

LITHIUM BUTTON CELL

Document Title: PB041616

CR1616

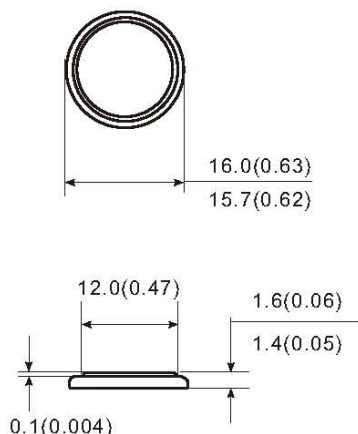

Unit:mm(inch)

Chemical System : Lithium/Manganese Dioxide

IEC Name: CR 1616

ANSI/NEDA: 5021LC

Camelion Model : CR1616

Average Weight : 1.2g

Dimension (\varnothing x H): 16.0^{-0.3}x1.6^{-0.2}mm
0.63^{-0.01}x0.06^{-0.01}inch

Terminals: Flat

Nominal Voltage : 3.0Volts

Capacity :50mAh

(20±2°C, Rated at 30k Ω to 2.00V)

Standard Discharge Current: 0.1mA

Max. Continuous Discharge Current: 0.3mA

Max. Pulse Discharge Current: 8.0mA

Operating Temperature: -20°C~60°C

Storage Conditions

Temperature: -20°C~45°C

Relative Humidity: 60±15%

Cross Reference: E-CR1616(Energizer),
DL1616(Duracell),KECR1616(Rayovac)

Discharge characteristics

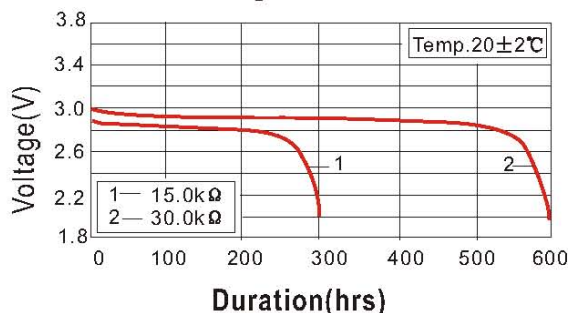

Temperature Characteristics

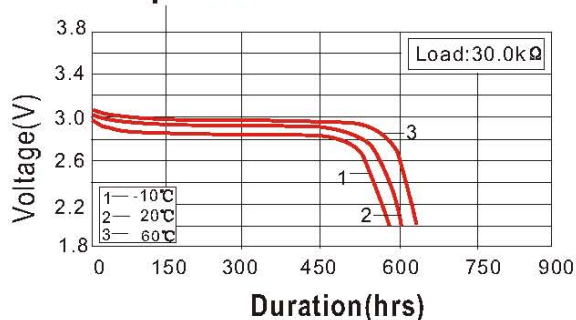

Load-capacity characteristic

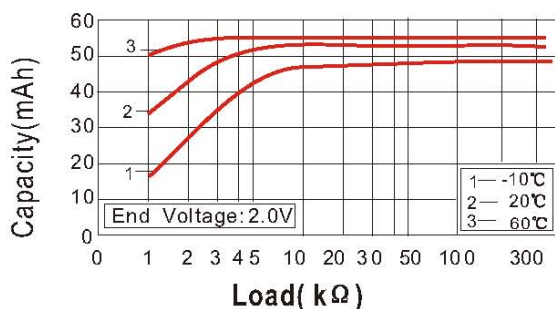

Pulse Discharge Characteristic

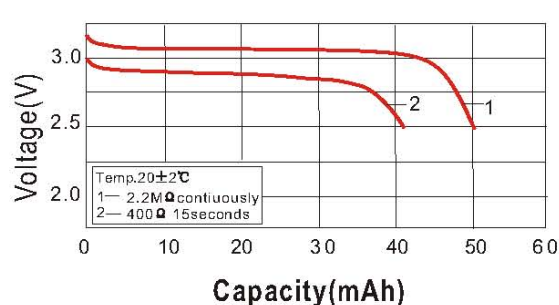

Notice:

Environmental elements comply with RoHS requirements. This information is subject to change without prior notice and for reference only. It should not be used as a basis for a product guarantee or warranty. For additional information, please consult your nearest Camelion Sales Office or Distributor or visit our website at: www.camelionbattery.com.